

SchönhuberFranchi

BUFFET

03 | 2023

BUFFET

6	Buffet Alzate Cube e Ypsilon
16	Buffet system
28	Bevande Caldo e Freddo
	Drinks Hot and Cold
	Getränke Kalt und Heiß
32	Pane & Pasticceria Neutro e Refrigerato
	Bread & Pastries Neutral and Refrigerated
	Brot & Gebäck Normal und Kühlbar
38	Salato Neutro e Refrigerato
	Savoury Neutral and Refrigerated
	Kalte Platte Normal und Kühlbar
42	Chafing dish Caldo
	Chafing dish Hot
	Speisewärmer Warme
46	Butler Tavolo tessile
	Butler Textile table
	Butler
62	Alfred
66	SchönhuberFranchi Tailor made

SchönhuberFranchi racconta una storia che viene da lontano, fatta di eccellenza, di grande competenza, ma soprattutto di passione.

Un partner in grado di creare uno stile elegante, raffinato ed accogliente, sempre teso a migliorare l'essenza e i valori dell'ospitalità.

SchönhuberFranchi tells a story coming from way back, made with excellence, with great competence, but most of all with passion. Partner capable of creating an elegant style, refined and welcoming, always aiming to improve the essence and values of hospitality.

Die langjährige Geschichte der Marke SchönhuberFranchi ist geprägt von herausragender Exzellenz, großer Kompetenz und vor allem Leidenschaft für die schönen Dinge.

SchönhuberFranchi ist ein Partner, der stets einen eleganten, raffinierten und einladenden Stil kreiert und der die Bedeutung sowie die Werte der Gastfreundschaft konstant verbessert.

Buffet alzate Cube e Ypsilon

Design Marcello Ziliani

Per ottimizzare e velocizzare il servizio buffet, SchönhuberFranchi propone la collezione di alzate Cube e Ypsilon, di Marcello Ziliani, da utilizzare come base di appoggio per i diversi componenti a servire, come vassoi o centrotavola dalle dimensioni generose. In questo modo è possibile cambiare, e sostituire in modo pratico, gli elementi da portata e rendere la presentazione elegante e funzionale al tempo stesso.

To optimize and speed up the buffet service, SchönhuberFranchi offers the collection of Cube and Ypsilon cake stands, by Marcello Ziliani, to be used as a support base for the various serving components, such as trays or generously sized centerpieces. In this way it is possible to change and replace the serving elements in a practical way and make the presentation elegant and functional at the same time.

Um den Buffetservice zu optimieren und zu beschleunigen, bietet SchönhuberFranchi die Tortenständer Cube und Ypsilon von Marcello Ziliani an, die als Unterlage für die verschiedenen Servierkomponenten wie Tablett oder großzügige Tafelaufsätze verwendet werden können. Auf diese Weise ist es möglich, die Servierelemente auf praktische Weise zu wechseln und auszutauschen und die Präsentation gleichzeitig elegant und funktional zu gestalten.



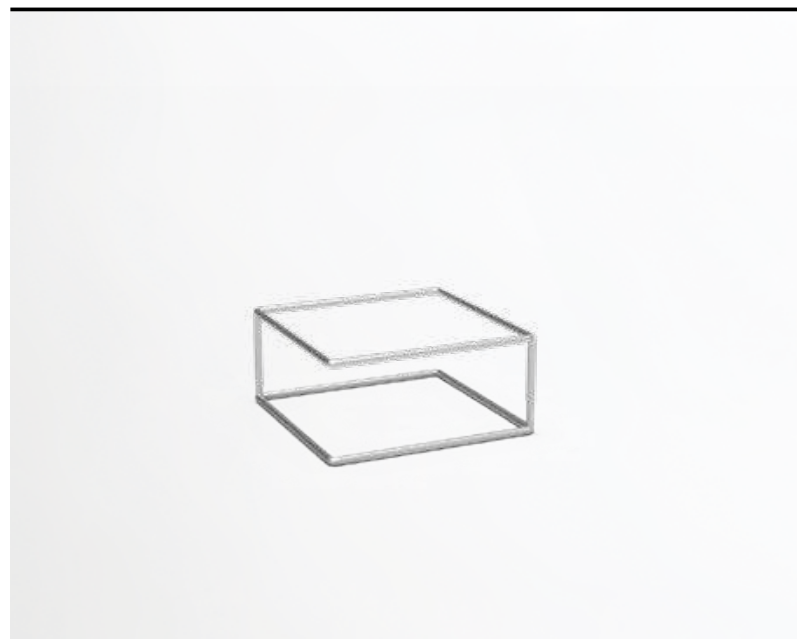

Alzata
support base, Stützbasis
mm 220x220 h 100

COL	COD
■	MT312VO110
□	MT312SW10

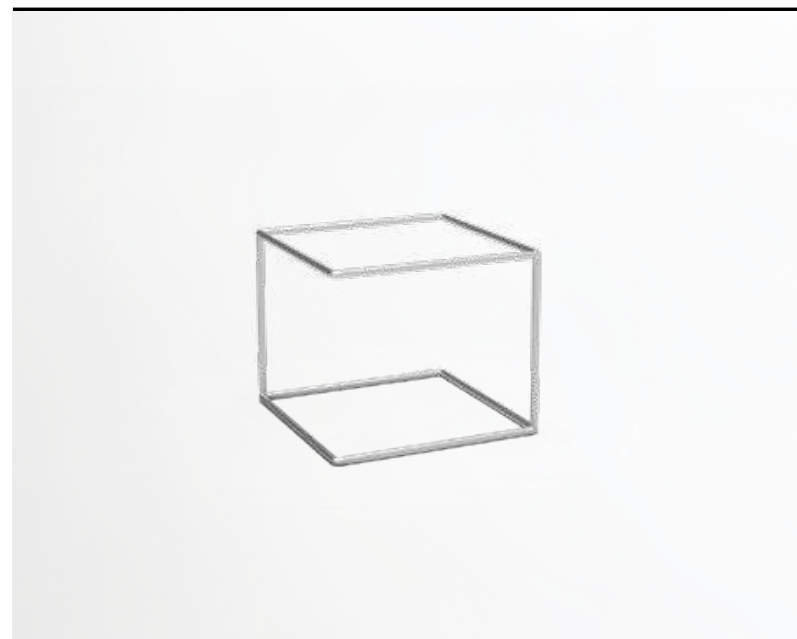

Alzata
support base, Stützbasis
mm 220x220 h 180

COL	COD
■	MT312VO118
□	MT312SW18



Alzata
support base, Stützbasis
mm 220x220 h 270

COL	COD
■	MT312VO127
□	MT312SW27



Alzata
support base, Stützbasis
mm 220x220 h 350

COL	COD
■	MT312VO135
□	MT312SW35



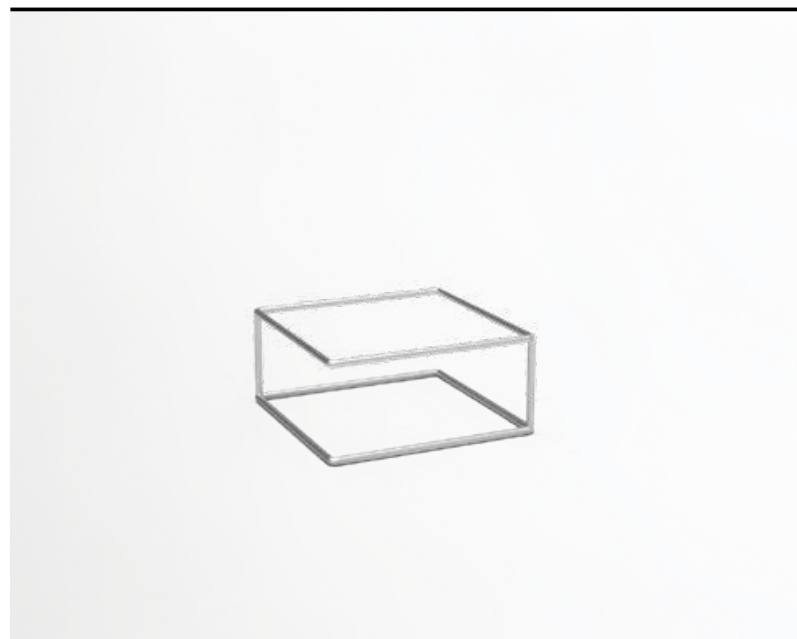

Alzata
support base, Stützbasis
mm 220x220 h 100

COL	COD
■	MT312VO110
□	MT312SW10

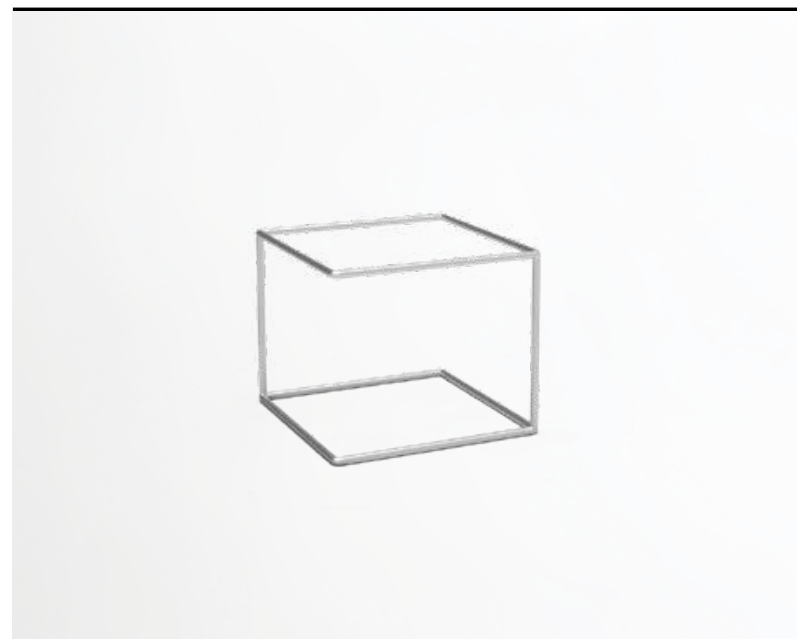

Alzata
support base, Stützbasis
mm 220x220 h 180

COL	COD
■	MT312VO118
□	MT312SW18



Piano orizzontale
horizontal plane, horizontale Ebene
mm 220x900 h 20

COL	COD
su richiesta on request auf Anfrage	MT312O3229



Portapane
bread basket, brotkorb
mm 245x245 h 80

MAT	COL	COD
frassino, ash, asche	su richiesta on request auf Anfrage	custom

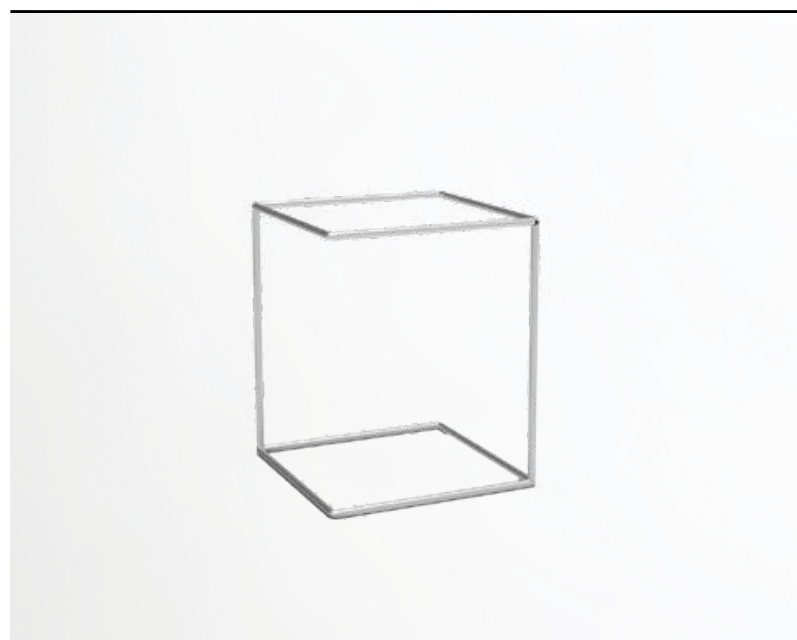

Alzata
support base, Stützbasis
mm 220x220 h 270

COL	COD
■	MT312VO127
□	MT312SW27

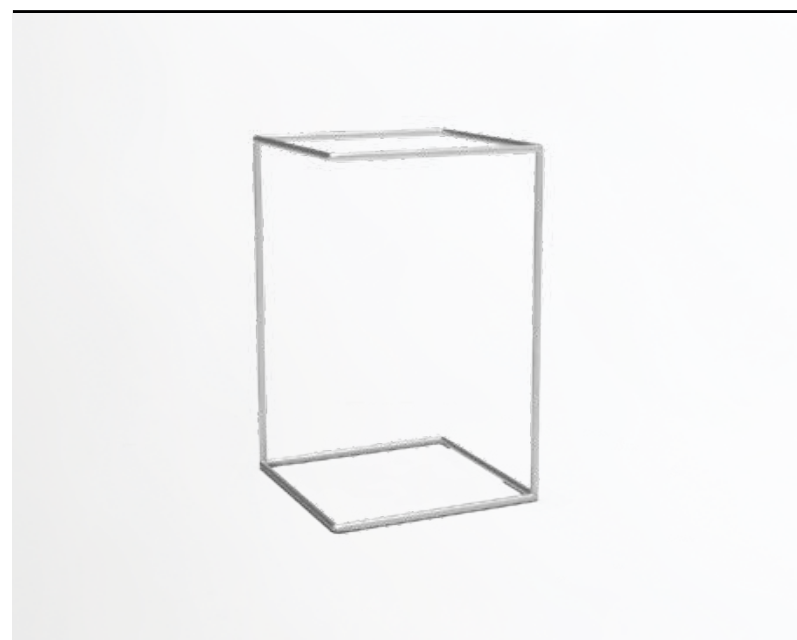

Alzata
support base, Stützbasis
mm 220x220 h 350

COL	COD
■	MT312VO135
□	MT312SW35





Alzata
support base, Stützbasis
mm 190x190 Ø224 h 180

COL	COD
■	MT309VO1
□	MT309SW



Alzata
support base, Stützbasis
mm 190x190 Ø224 h 270

COL	COD
■	MT309VO127
□	MT309SW27



Alzata
support base, Stützbasis
mm 190x190 Ø224 h 350

COL	COD
■	MT309VO135
□	MT309SW35



Buffet System

Design Lara Caffi

I buffet di Monica Armani e Lara Caffi sono due nuovi progetti modulari di grande versatilità e di raffinata eleganza. Il "banqueting", sistema sempre più utilizzato per eventi, colazioni di lavoro ma anche nella ristorazione professionale, viene elevato qualitativamente da SchönhuberFranchi attraverso un'offerta attenta al design del prodotto, sempre nel rispetto delle esigenze di operatività del cliente.

The buffets by Monica Armani and Lara Caffi are two new modular projects, versatile and elegant. Banquets are more and more popular for events, business lunch, and corporate meetings but also for restaurants and hotels; the SchönhuberFranchi banquet collections offer a high quality design product while meeting its client needs of service efficiency.

Die Buffets von Monica Armani und Lara Caffi sind zwei neue, modulare Konzepte, die von maximaler Vielseitigkeit und raffinierter Eleganz geprägt sind. Das Bankett erfreut sich bei Events und Unternehmensfrühstücks, aber auch im professionellen Restaurantbetrieb immer größerer Beliebtheit. SchönhuberFranchi wertet es mit seinem Angebot qualitativ hochwertigem Produkt-Design, das sämtliche Bedürfnisse des Kunden berücksichtigt, noch zusätzlich auf.





Elemento Verticale 3 Piani
vertical element 3 shelves,
vertikal 3 stöckiges element
mm 620x380 h 600

COL	COD
■	6 972V 301
□	6 9W2V 301



Elemento Verticale 2 Piani
vertical element 2 shelves,
vertikal 2 stöckiges element
mm 620x380 h 600

COL	COD
■	6 972V 201
□	6 9W2V201



Elemento Verticale
vertical element, vertikal stöckiges,
mm 265x380 h 600

COL	COD
■	6 972V 001
□	6 9W2V 001



Ganci Reggi Mensola
supporting shelf hooks, haken für glaskonsole
mm 200x380

COD
6 9720 003



Elemento Orizzontale
horizontal element, horizontales element
mm 580x380 h 110

COL	COD
■	6 972P 001
□	6 9W2P 001



Elemento Orizzontale Chaffing Dish
horizontal element for chaffing dish,
horizontales element für den speisewärmer
mm 580x380 h 210

COL	COD
■	6 972P CD1
□	6 9W2P CD1



Mensola Vetro
glass shelf, glaskonsole
mm 1200x380

COL	COD
■	6 9720 001
□	6 9720 002



Cupola Rettangolare gn 1/1
rectangular cloche gn 1/1, rechteckig cloche gn 1/1

COD
9 71NO 112



**Piastra eutettica gn 1/1**

gel packs gastronorm gn 1/1, kühltablett gn 1/1

MAT	H mm	COD
acciaio steel stahl	10	5 46400 009

**Set Yogurt**

yoghurt set, yogurtsatz

Q.TÀ	ART	MAT	H mm	COD
1	gastronorm 1/1	acciaio steel stahl	65	6 F113 290
1	gastronorm 1/1 22 fori/holes/hackbrett		20	

**Set Uova/Burro/Marmellata**

set for eggs/butter/jams, Ei/Butter/Marmeladesatz

Q.TÀ	ART	MAT	H mm	COD
2	gastronorm 1/2	acciaio steel stahl	65	6 F11F 310
1	gastronorm 1/2 25 fori/holes/hackbrett		40	
1	gastronorm 1/2		40	

**Set Porta Affettati**

set for cured meats, aufschnittesatz

Q.TÀ	ART	MAT	H mm	COD
1	gastronorm 1/1	acciaio steel stahl	65	6 FO95 095
1	gastronorm 1/1		20	

**Set Tagliere Formaggi**

cheese board set, käsebrettsatz

Q.TÀ	ART	MAT	H mm	COD
1	gastronorm 1/1	acciaio steel,stahl	20	6 FO95 094
1	tagliere, tray, tablett	PE	20	

**Set Pane**

bread set, brotsatz

Q.TÀ	ART	MAT	H mm	COD
1	gastronorm 1/1	acciaio steel,stahl	20	6 F113 680
1	tagliere, tray, tablett	legno wood, holz	20	

**Set Porta Verdure**

vegetable holder set, gemüsesatz

Q.TÀ	ART	MAT	H mm	COD
1	gastronorm 1/1	acciaio steel stahl	65	6 F113 282
2	gastronorm 2/8		40	
1	gastronorm 1/2 forata, with holes, mit Locher		40	

**Set Pasticceria**

pastries set, Gebäcksatz

Q.TÀ	ART	MAT	H mm	COD
1	gastronorm 1/1	acciaio steel, stahl	20	6 FO95 092



Set Porta Ghiaccio
ice bucket, eisbehälter

Q.TÀ	ART	MAT	H mm	COD
1	gastronorm 1/1	acciaio steel, stahl	200	6 F112 002

Set Chaffing Dish
chaffing dish set, speisewärmersatz

Q.TÀ	ART	MAT	H mm	COD
1	chaffing dish c. frizione/ with brake/mit bremsse	acciaio steel, stahl	100	6 FCDF 002
1	resistenza elettrica electrical resistance elektroheizplatte	-	-	P 97150 118





Bevande Caldo e Freddo
Drinks Hot and Cold
Getränke Kalt und Heiß





Elemento Porta Brocche Verticale Refrigerato

vertical reffridgerated jug holder,
gekühltes vertikales element für karaffen

ART	COD
piastra eutettica 1/1 gel packs 1/1, kühltablett 1/1	5 46400 009
elemento verticale 2 piani, vertical element 2 shelves, vertikal 2-stöckiges element	6 972V 301 <input checked="" type="checkbox"/> 6 9W2V 301 <input type="checkbox"/>



Porta Ghiaccio

ice bucket, eisbehälter

ART	COD
gastronorm 1/1 h 200	6 F112 002
elemento orizzontale chaffingdish, horizontal element for chaffingdish, horizontales element für den speisewärmer	6 972P CD1 <input checked="" type="checkbox"/> 6 9W2P CD1 <input type="checkbox"/>



Distributore bevande fredde 7 lt
cold drink dispenser 7 lt, sagspender-element 7lt

ART	COD
piastra eutettica, gel packs, kühltablett	5 46400 010
distr. c/c, dispenser w/c, getrankespender	2 90032 716
griglia c/piattino salva goccia, grill with drip plate, runder grill mit tropfenteller	6 9720 000
elemento verticale, vertical element, vertikal element	6 972V 001 <input checked="" type="checkbox"/> 6 9W2V 001 <input type="checkbox"/>



Distributore bevande calde 7 lt
hot drink dispenser 7 lt, wärmgetränkspender-element 7 lt

ART	COD
resistenza el., el. resistance, elektroheizplatte	3 60888 102
distr. c/c, dispenser w/c, getrankespender	2 90032 716
griglia c/piattino salva goccia, grill with drip plate, runder grill mit tropfenteller	6 9720 000
elemento verticale, vertical element, vertikal element	6 972V 001 <input checked="" type="checkbox"/> 6 9W2V 001 <input type="checkbox"/>



Pane & Pasticceria Neutro e Refrigerato
Bread & Pastries Neutral and Refrigerated
Brot & Gebäck Normal und Kühlbar





Doppio elemento gn Brioches/Uova/Burro/Marmellata
double element gn brioche/eggs/butter/jams,
gn doppellement brioche/ei/butter/marmeladesatz

ART	COD
set pasticceria gn 1/1 , pastries set, giebäckesatz gn 1/1	6 FO95 O92
set burro/ marmellata, set for butter/jams, butter und marmeladesatz	6 F11F3 10
elemento verticale 2 piani vertical element 2 shelves vertikal 2-stöckiges element	6 972V 201 <input checked="" type="checkbox"/> 6 9W2V 201 <input type="checkbox"/>



Doppio elemento gn set yogurt
double element gn yoghurt set,
gastronom doppellement yogurtsatz

ART	COD
ciotola acciaio coib., insulated steel bowl bowl aus isoliertem edelstahl ø cm 33	3 43002 633
piastra eutettica 1/1, gel packs 1/1, kühltablett 1/1	5 46400 009
elemento verticale 2 piani vertical element 2 shelves vertikal 2-stöckiges element	6 972V 201 <input checked="" type="checkbox"/> 6 9W2V 201 <input type="checkbox"/>



Elemento singolo gn Uova/Burro/Marmellata
single elements gn eggs/butter/jams,
einzelne gn element ei/butter/marmeladesatz

ART	COD
set uova/burro/marmellata, set for eggs/butter/ jams, ei/butter/marmeladesatz	6 F11F 310
elemento orizzontale, horizontal element, horizontales element	6 972P 001 <input checked="" type="checkbox"/> 6 9W2P 001 <input type="checkbox"/>



Elemento singolo gn Pasticceria
single elements gn pastries,
einzelne gn element gebäck

ART	COD
set pasticceria, pastries set, gebäckesatz	6FO95O92
elemento orizzontale, horizontal element, horizontales element	6972POO1 <input checked="" type="checkbox"/> 69W2POO1 <input type="checkbox"/>



Doppio elemento gn Cereali/Uova/Burro/Marmellata
double element gn cereals/eggs/butter/jams,
gn doppellement musli/ei/butter/marmeladesatz

ART	COD
6 cont. c/c, 6 container w/c, 6 behälter m/d	2 90003 215
piastra eutettica 1/1, gel packs 1/1, kühltablett 1/1	5 46400 009
set Uova/Burro/Marmellata set eggs/butter/jams, ei/butter/marmeladesatz	6 F11F 310
elemento verticale 2 piani vertical element 2 shelves vertikal 2-stöckiges Element	6 972V 201 <input checked="" type="checkbox"/> 6 9W2V 201 <input type="checkbox"/>



Doppio elemento gn set Pane e Pasticceria
double element gn pastries and bread set,
gastronom doppellement gebäckesatz und brotsatz

ART	COD
set pane, bread set, brotsatz	6F113680
set pasticceria, pastries set, gebäckesatz	6FO95O92
elemento verticale 2 piani vertical element 2 shelves vertikal 2-stöckiges Element	6972V201 <input checked="" type="checkbox"/> 69W2V201 <input type="checkbox"/>



Elemento singolo gn Yogurt
single elements gn yoghurt,
einzelne gn element yogurt

ART	COD
set porta yogurt, yoghurt set, yogurtsatz	6F113290
elemento orizzontale, horizontal element, horizontales element	6972POO1 <input checked="" type="checkbox"/> 69W2POO1 <input type="checkbox"/>



Elemento singolo gn Pane
single elements gn bread,
einzelne gn element brot

ART	COD
set pane, bread set, brotsatz	6F113680
elemento orizzontale, horizontal element, horizontales element	6972POO1 <input checked="" type="checkbox"/> 69W2POO1 <input type="checkbox"/>



Portapane
bread basket, brotkorb
mm 300X300 H 80

MAT	COD
frassino, ash, esche	6971708



Vassoio
tray, tablett
mm 530X325 H 50

MAT	COD
faggio, beechwood, buchenholz	C314500103



Salato Neutro e Refrigerato
Savoury Neutral and Refrigerated
Kalte Platte Normal und Kühlbar





Doppio elemento gn Salumi e Formaggi

double element gn cured meats and cheese,
gn doppel-element aufschnitt und käselet

ART	COD
set porta affettati, set for cured meats, aufschnittesatz	6 F095 O95
set tagliere formaggio, cheese board set, käsebrettsatz	6 F095 O94
elemento verticale 2 piani vertical element 2 shelves vertikal 2-stöckiges Element	6 972V 201 <input checked="" type="checkbox"/> 6 9W2V 201 <input type="checkbox"/>



Doppio elemento gn Verdure e Formaggi

double element gn vegetable and cheese,
gn doppel-element gemüse und käselet

ART	COD
set porta verdure, vegetable holder set, gemüsesatz	6 F113 282
set porta affettati, set for cured meats, aufschnittesatz	6 F095 O95
elemento verticale 2 piani vertical element 2 shelves vertikal 2-stöckiges Element	6 972V 201 <input checked="" type="checkbox"/> 6 9W2V 201 <input type="checkbox"/>



Elemento singolo gn Porta Affettati

single element gn cured meats,
einzelne gn aufschnitte

ART	COD
set porta affettati, set for cured meats, aufschnittesatz	6 F095 O95
elemento orizzontale, horizontal element, horizontales element	6 972P 001 <input checked="" type="checkbox"/> 6 9W2P 001 <input type="checkbox"/>



Elemento singolo gn Porta Affettati Piani in Grès

single element gn plates in gres for cold cuts and cheese,
einzelne gn gresplatter für Käse und Aufschnitte
gresplatter für Käse und Aufschnitte

ART	COD
2 piastre gres salumi e formaggi, 2 plate gres for cold cuts and cheeses, gresplatter für Käse und aufschnittesatz	6 5716 2F6
elemento orizzontale, horizontal element, horizontales element	6 972P 001 <input checked="" type="checkbox"/> 6 9W2P 001 <input type="checkbox"/>



Elemento singolo gn Tagliere Formaggio

single element gn cheese board,
einzelne gn käsebrettsatz

ART	COD
set tagliere formaggio, cheese board set, käsebrettsatz	6 F095 O94
elemento orizzontale, horizontal element, horizontales element	6 972P 001 <input checked="" type="checkbox"/> 6 9W2P 001 <input type="checkbox"/>



Elemento singolo gn Porta Verdure

single element gn vegetable holder,
einzelne gn gemüsesatz

ART	COD
set porta verdure, vegetable holder set, gemüsesatz	6 F113 282
elemento orizzontale, horizontal element, horizontales element	6 972P 001 <input checked="" type="checkbox"/> 6 9W2P 001 <input type="checkbox"/>

Chafing dish Caldo
Chafing dish Hot
Speisewärmer Warme





Elemento singolo gn Chaffing Dish
single elements gn chaffing dish,
einzelne gn element speisewärmer

ART	COD
resistenza el., el. resistance, elektroheizplatte	P 9715O 118
chaffing dish c/frizione, with brake, mit Bremse	6 FCDF OO2
El. orizzontale chaffingdish, horizontal el. for chafingdish, horizontales für den speisewärmer	6 972P CD1 <input checked="" type="checkbox"/> 6 9W2P CD1 <input type="checkbox"/>



Elemento Triplo di servizio
triple service element, dreifacher dienstelement

ART	COD
2 piastra gres salumi e formaggi, 2 plate grès for cold cuts and cheeses, gresplatter für Käse und aufschnittesatz	6 5716 2F6
elemento verticale 3 piani, vertical element 3 shelves, vertikal 3-stöckiges element	6 972V 3O1 <input checked="" type="checkbox"/> 6 9W2V 3O1 <input type="checkbox"/>



Butler Tavolo tessile
Butler Textile table
Butler Stofftisch
Design Monica Armani





Modulo standard gn porcellana
module for standard gn in porcelain,
standard gn element aus porzellan
mm 406x648

COD
5 29001 053



Modulo standard gn in acciaio
module for standard gn in steel,
standard gn element aus stahl
mm 406x648

COD
5 29001 050



Separatore
separator, scheidler

D	COD
1/2	5 29001 200
1/3	5 29001 300



Prolunga angolare
corner extension, eckige Verlängerung

COD
5 29001 004



Modulo Chafing Dish doppio
double module chaffing dish,
standard double speisewärmer
mm 812x648

COD
5 29001 054



Vassoio cieco
tray, tablett
mm 406x648

COD
5 29001 055



Prolunga dritta
straight extension, rechte verlängerung
mm 1200x686

COD
5 29001 003





Set Pasticceria Acciaio/Porcellana

pastries set steel/pocelain,
gebäcksatz stahl/porzellan
mm 406x648

ART	COD
modulo standard gn 1/1 standard module gn 1/1 standard gn element 1/1	5 29001 053
gn 1/1 porcellana, porcelain, porzellan	2 01BUG N11



Set Porta Yogurt 19 fori in acciaio

yoghurt set 19 holes in steel,
yogurtsatz 19 löcher stahl
mm 406x648

ART	COD
modulo standard gn 1/1 standard module gn 1/1 standard gn element 1/1	5 29001 050
set porta yogurt, yoghurt set, yogurtsatz	6 F113 290



Set Porta Verdure acciaio/porcellana

vegetable holder set steel/porcelain ,
gemüsesatz stahl/porzellan
mm 406x648

ART	COD
modulo standard gn 1/1 standard module gn 1/1 standard gn element 1/1	5 29001 050
set porta verdure, vegetable holder set, gemüsesatz	6 F113 282



Set Uova/Burro/Marmellata

set for eggs/butter/jams, ei/butter/marmeladesatz
mm 406x648

ART	COD
modulo standard gn 1/1 standard module gn 1/1 standard gn element 1/1	5 29001 050
set uova/burro/marmellata, set for eggs/butter/ jams, ei/butter/marmeladesatz	6 F11F 310



Set Tagliere Formaggi acciaio

cheese board set steel , Käsebrettsatz stahl
mm 406x648

ART	COD
modulo standard gn 1/1 standard module gn 1/1 standard gn element 1/1	5 29001 050
set tagliere formaggio, cheese board set, käsebrettsatz	6 FO95 094



Set Porta Affettati acciaio

set for cured meats steel , aufschnitte stahl
mm 406x648

ART	COD
modulo standard gn 1/1 standard module gn 1/1 standard gn element 1/1	5 29001 050
set porta affettati, set for cured meats aufschnittesatz	6 FO95 095



Modulo Tagliere

cutting board module, standard hackbrett
mm 406x648

ART	COD
modulo taglierei, cutting board module, standard hackbrett	5 29001 051



Set Chafing Dish

chaffing dish set, speisewärmersatz
mm 812x648

ART	COD
modulo c/d doppio, double module c/d, doppelement c/d	5 29001 054
chaffing dish c/frizione, with brake, mit bremse	6 FCDF 002
resistenza elettrica electrical resistance elektroheizplatte	P 97150 118







Tavolo butler
butler table, butler tisch
mm 3040x774 H 896

MAT	COD
acciaio inox, stainlesssteel, edelstahl	5 29000 998



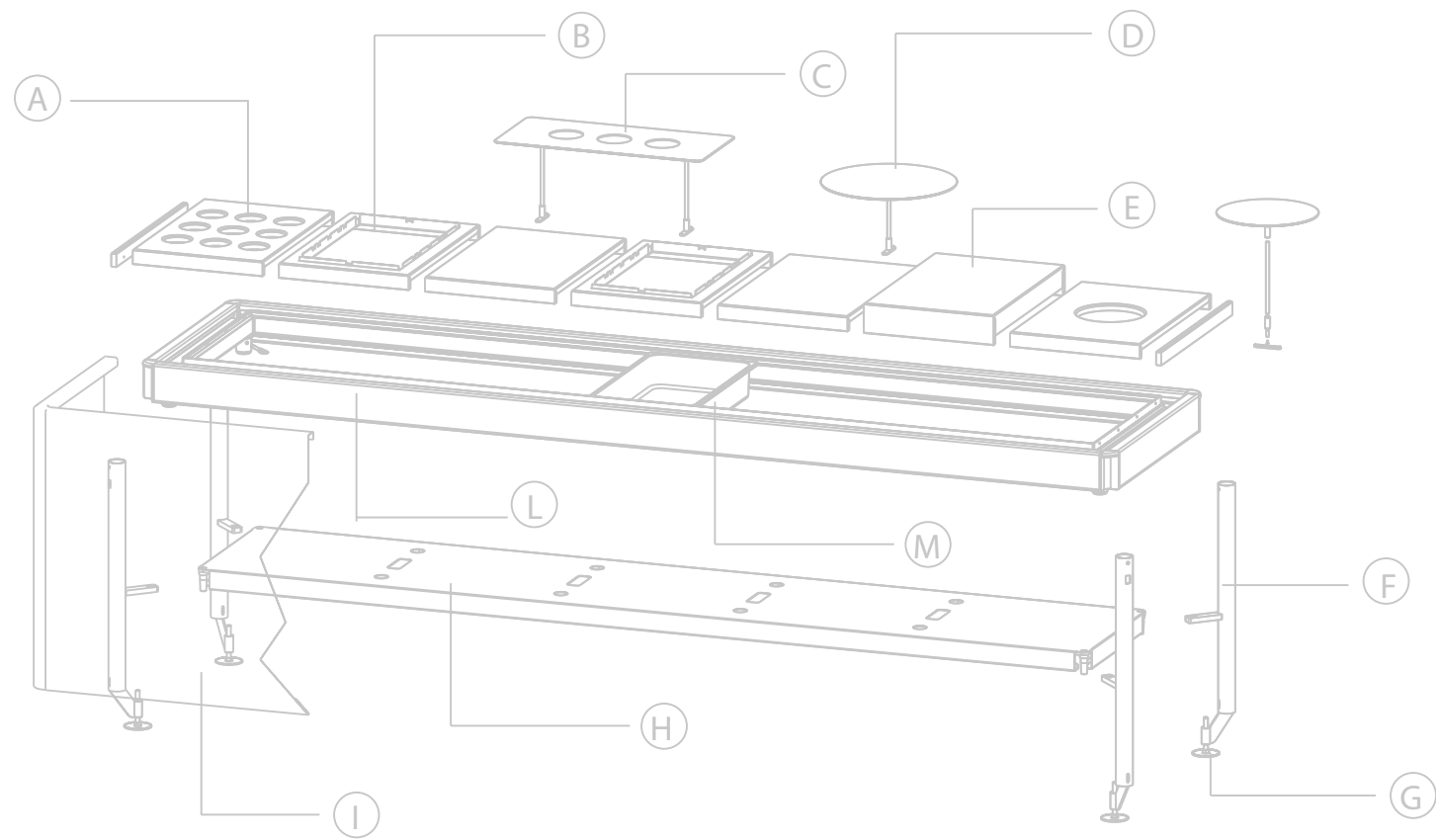

- A** Modulo top posizionabile
Positionable top, Anbringendes top
- B** Modulo top gastronorm
Top gastronorm module, Gastronorm top
- C** Porta salse
Sauce holder, Soßenbehälter
- D** Alzatina display system
Raised display stand, Etagere display system
- E** Modulo tagliere
Cutting board module, Schneidebrettelement
- F** Gambe
Legs, Beine
- G** Piedino registrabile
Adjustable feet, Aerstellbarer Fuß
- H** Sottopiano
Undermount, Untere Auflage
- I** Vestiito
Dress, Die Bekleidung
- L** Frame/struttura in AL estruso
Frame/structure in extruded AL, Struktur in extrudiertem
- L1** Dettaglio dell'estruso in AL
Detail der extrusion in AL, Extruded AL in detail
- M** Bagnomaria
Bain-marie, Bain-Marie

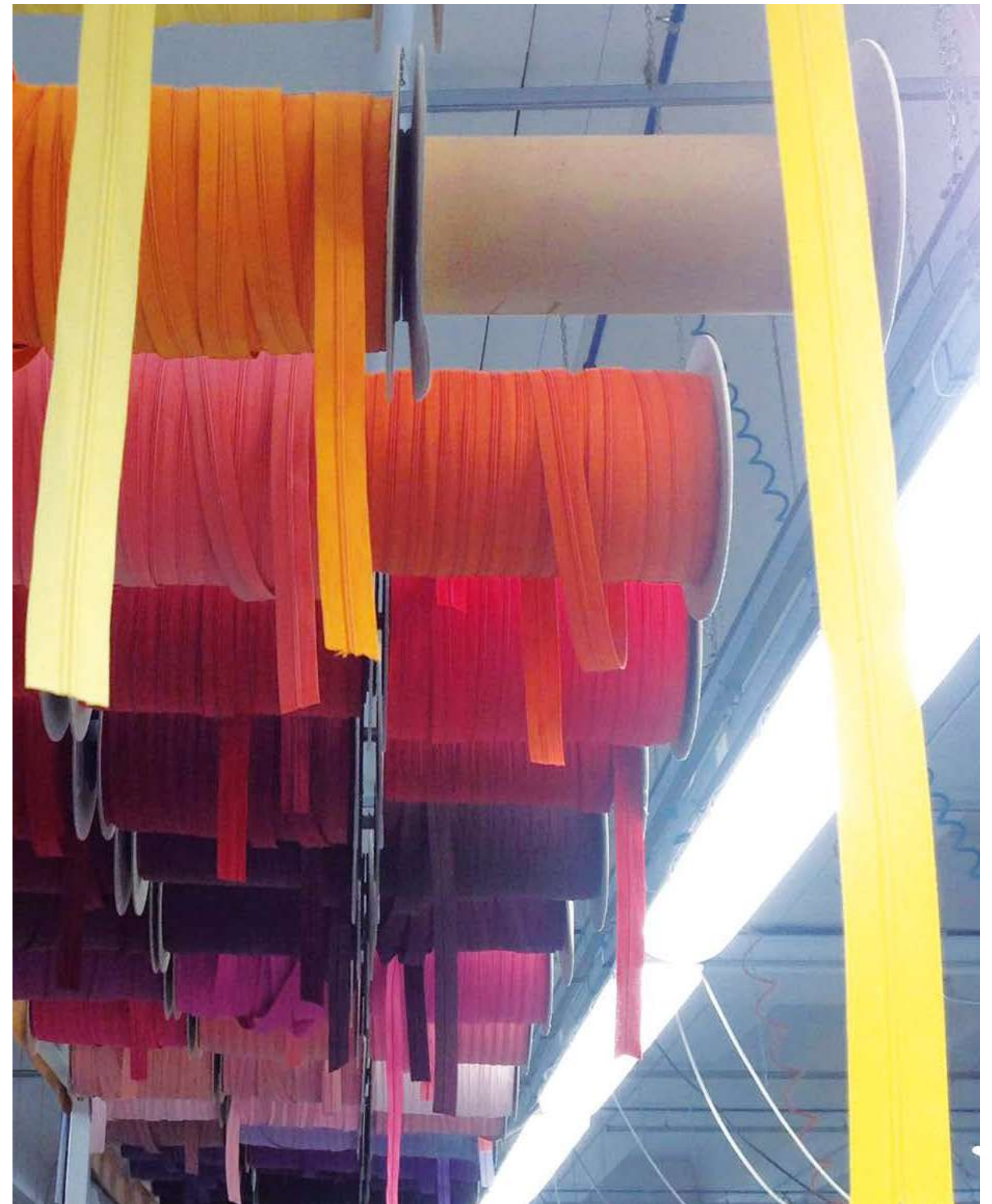
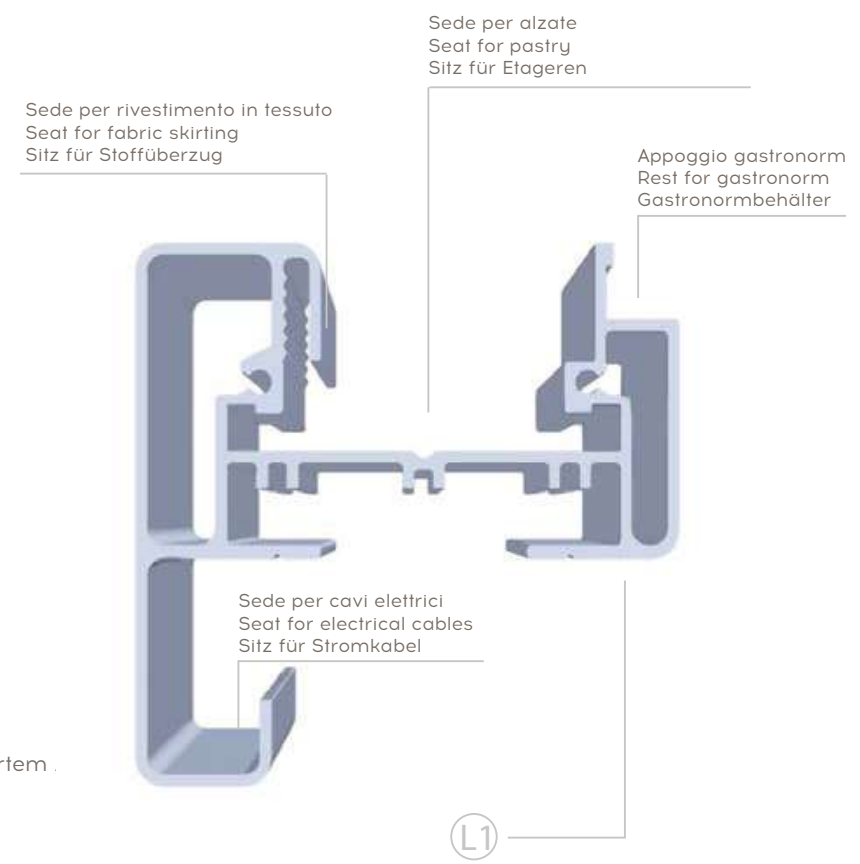

Alfred
design Piero Lissoni

Il carrello multifunzionale rettangolare disegnato da Piero Lissoni in acciaio con piani in legno intercambiabili si aggiunge come arredo di servizio funzionale ai buffet o complementare alla tavola.

The rectangular multifunction trolley designed by Piero Lissoni, in steel with interchangeable wooden levels, is an additional item that can be used for buffet or table service.

Der von Piero Lissoni entworfene, rechteckige Multifunktionswagen aus Edelstahl mit austauschbaren Holzböden ist die perfekte Ergänzung als Servicewagen bei Buffets oder als Beistelltischchen am Esstisch.





Carrello
trolley, wagen
mm 1000x600 H 855

MAT	COD
acciaio inox, stainlesssteel, edelstahl	4 87000 101
metallo verniciato, painted metal, lackiertes Metall	4 87000 102



SchönhuberFranchi

Tailor made

Il marchio SchönhuberFranchi è associato ad alcuni degli hotel icona del XX secolo raggiungendo una grande credibilità nella realizzazione degli interni di luxury hotel, residence, bar e ristoranti.

Il nostro lavoro si sviluppa in un'ottica di partnership nella convinzione che solo così sia possibile seguire da vicino la filosofia del progettista e dare forma ad ogni concezione dello spazio. Maestria artigianale, perfezione in ogni dettaglio, attenzione costruttiva, accurata selezione e utilizzo sapiente dei materiali e si incontrano in una sintesi unica.

L'obiettivo è esaltare un'atmosfera, valorizzare la bellezza di uno spazio e la sua funzionalità.

The brand name SchönhuberFranchi is associated with some of the top hotels of the XX century obtaining high credibility in the realization of interiors for luxury hotels, residences, bars and restaurants.

Our work develops with a form of partnership with the belief that only in this way it is possible to closely follow the philosophy of the designer and to give form of space to every conception. Craft mastery, perfection to every detail, constructive attention, accurate selection and competent use of materials join together in a unique synthesis.

Die Marke SchönhuberFranchi bringt man immer wieder mit einigen Hotelikonen des 21. Jahrhunderts in Verbindung. Das verschafft ihr eine hohe Glaubwürdigkeit in Bezug auf die Entwicklung von Interieurs von Luxushotels, Residenzen, Bars und Restaurants.

In unserer Arbeit legen wir großen Wert auf Partnerschaften, denn wir sind überzeugt, dass es nur mit solchen möglich ist, die Philosophie und das Konzept des Planers richtig zu begreifen und in Folge seinem Raumkonzept Form zu geben. Meisterhafte Handwerkskunst, Perfektion bis ins kleinste Detail, bauliches Wissen, sorgfältige Auswahl sowie fachkundige Verwendung der Materialien verschmelzen in einer einzigartigen Synthese. Unser Ziel ist es, eine Atmosphäre zu schaffen, die begeistert, und der Schönheit des Raumes sowie seiner Funktionalität einen Mehrwert zu geben.

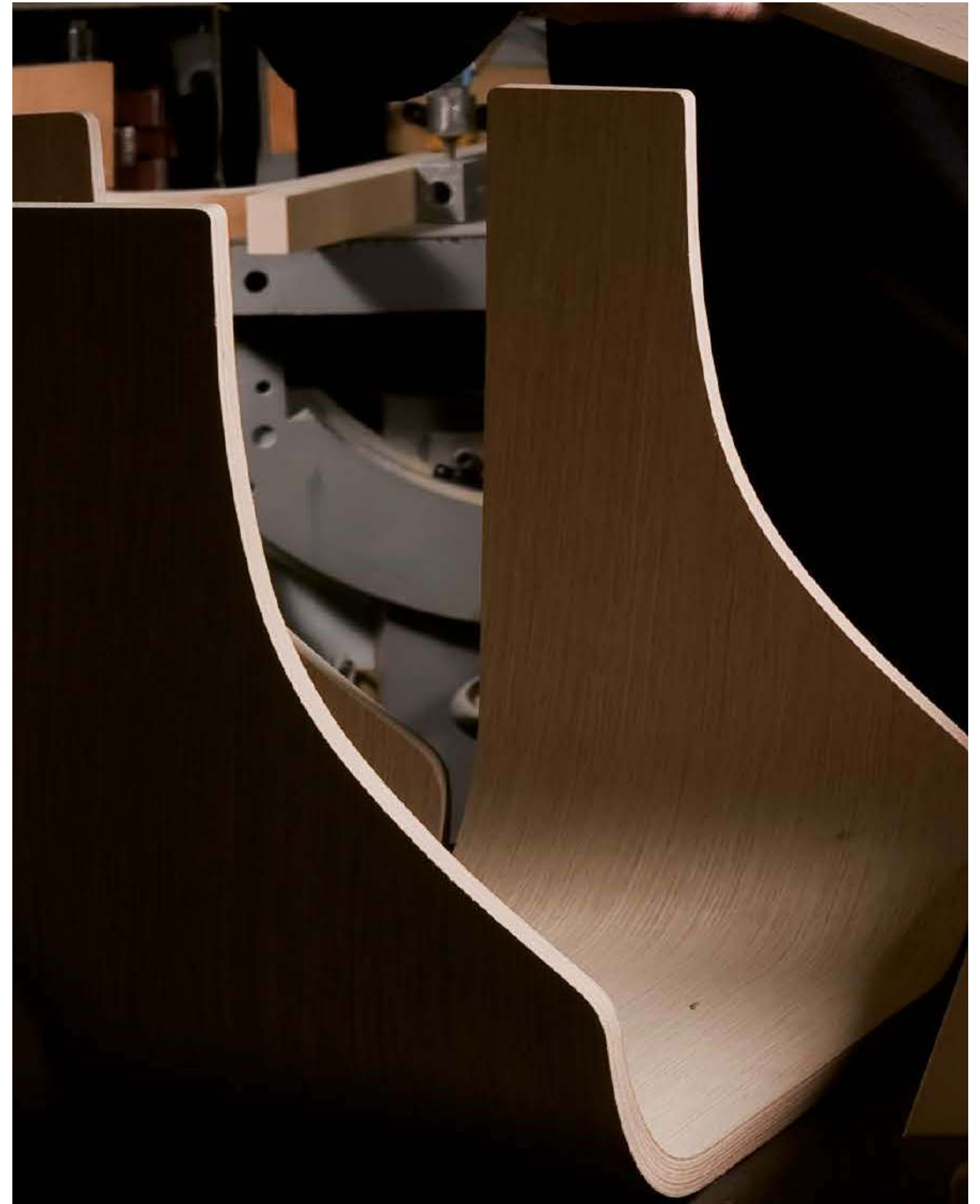

Progetto grafico Graph.X

Styling Lara Caffi

Foto Nicolò Brunelli

Stampa Graphic Center, 2023

